

Dual

1211

Automatic turntable



Operating instructions

Dual 1211

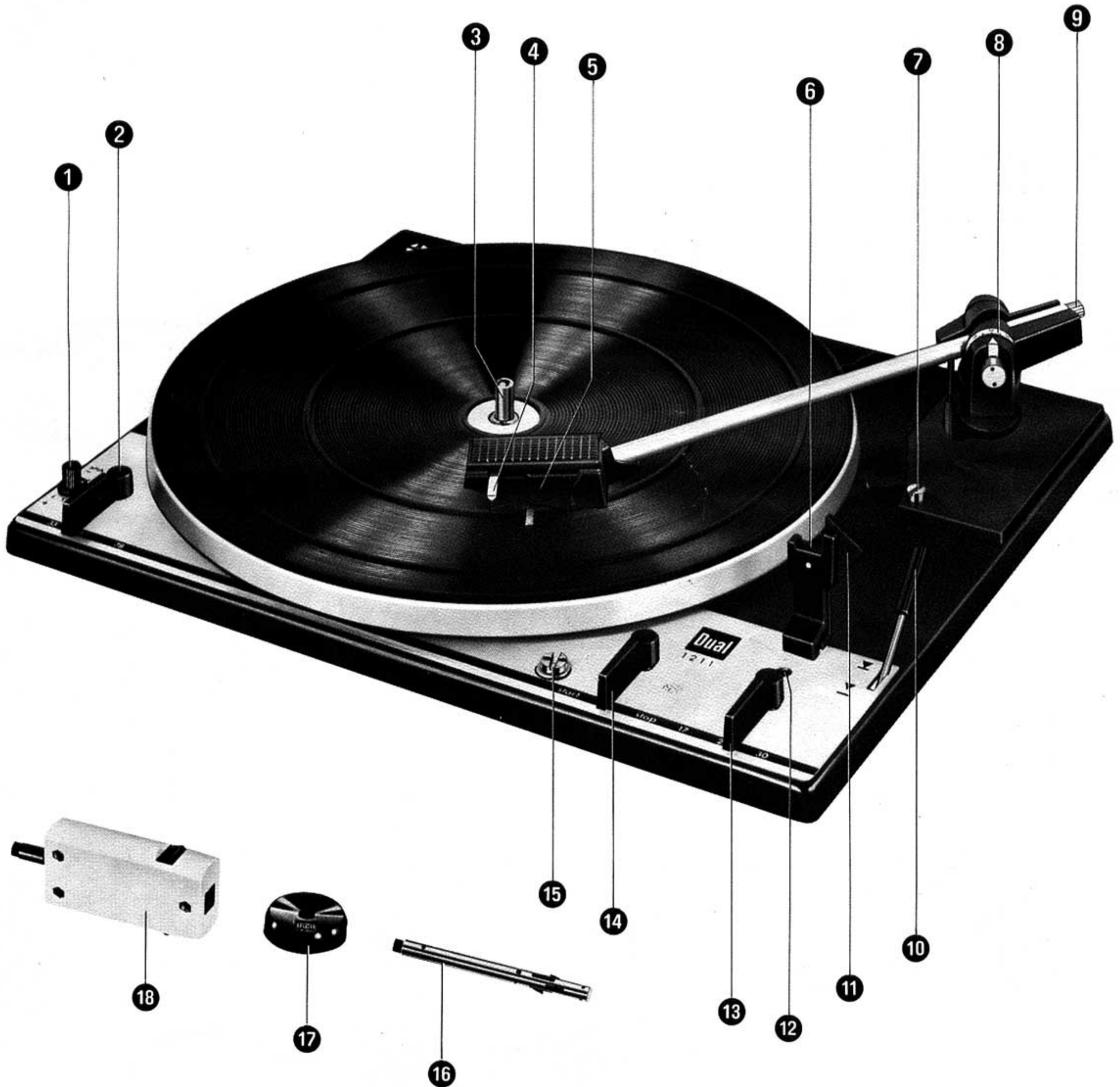

Dear Record Lover:

Please read these instructions carefully before you set up and operate your new automatic turntable. By doing so, you will avoid faulty operation or possible damage due to mistakes in installation.

Move page 2 outward.

Unpacking

Remove all parts used for packing, including the wedges between the chassis and the turntable. Notice whether a cartridge is mounted in the tonearm head and remove the protective cap that may be over the stylus. Instructions for mounting the cartridge as well as technical data on factory-mounted cartridges can be found on a separate sheet enclosed with this instruction manual.

Set stylus pressure dial to 0. If the tonearm does not float freely in a horizontal position, adjust balance as described on page 10. Now set stylus pressure to that recommended for your cartridge.

Note: After initial installation and after every transport, allow the automatic mechanism to adjust itself by operating the unit through one change cycle with the tonearm locked on its rest (move the operating lever to "start").

Installation

The installation instruction is only important if the phonograph is bought without base.

Press the chassis mounting screws toward the edge of the chassis with your thumbs and set the chassis down on the base cut-out so that the three spring cups slip into their holes (A). Then turn the mounting screws clockwise. The chassis is now spring-mounted (B).

To secure the unit for transport, unscrew the mounting screws, pull them up, then

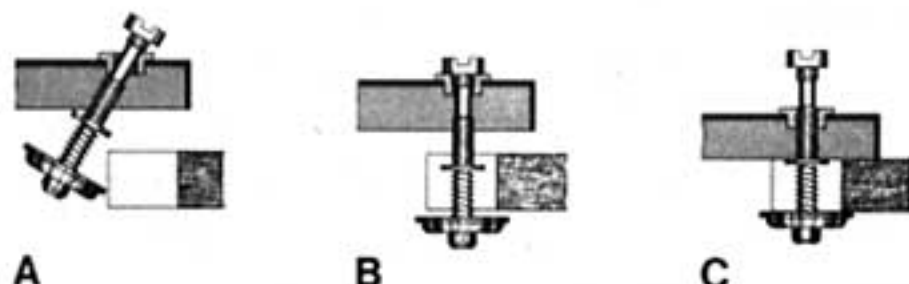

Fig. 1

turn them further until the chassis is secured tightly to the mounting board (C). To prepare the unit for use again, turn the two screws clockwise until they slide down about 3/4", then continue to turn in the same direction until they are tight.

Power-line connections

For units already installed in console or compact systems, consult the instructions for the system.

The unit can be used with 50 or 60 Hz alternating current, at 110 or 220 volts. It is normally pre-set for 220 volts, 50 Hz.

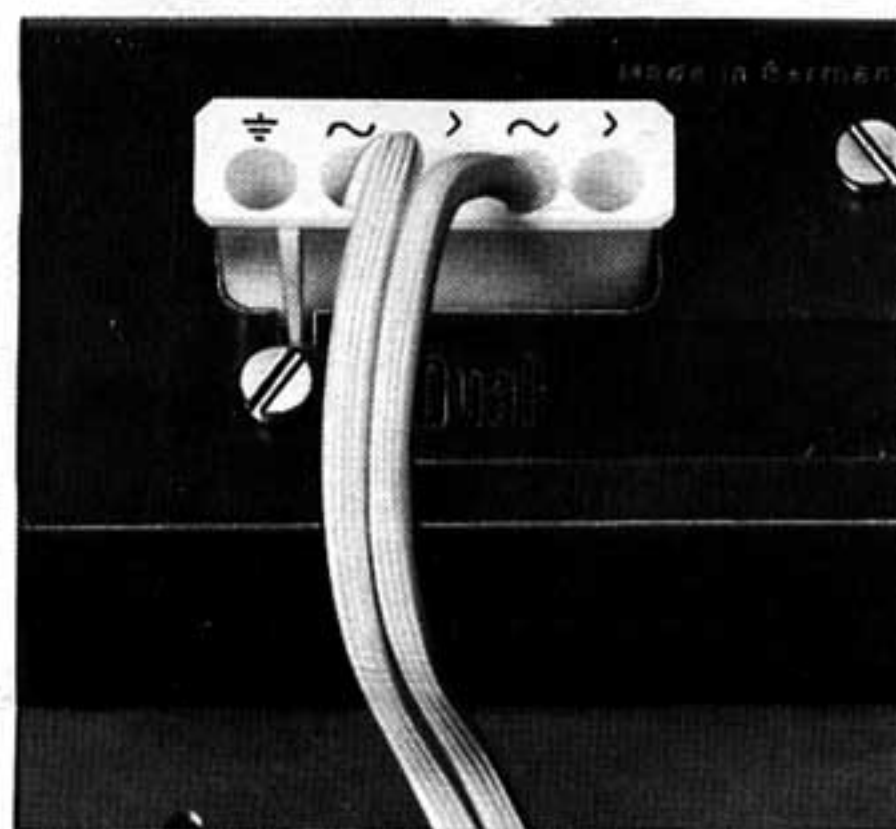

Fig. 2

If a different voltage supply and/or frequency becomes necessary please consult your dealer or an authorized Dual Service Station.

To change over the voltage, remove the power switch cover.

Changeover is carried out according to model by switching over or reconnecting the motor supply leads using the connection diagram in the power switch cover.



Fig. 3

The power switch is designed so that pre-amplifiers or power amplifiers can be switched on or off automatically as the unit is turned on or off.

The load on the power switch must not exceed 400 VA (Volt-amperes). It is generally used only with all-transistor amplifiers, which have no warm-up delay.

The connection is made to contacts provided on the plug portion of the power switch.

In this case, the line cord is to be fitted with AMP plugs as follows:

For 5-contact connector B. No. 213 982, AMP No. 160 565/1 (Fig. 2)

For 4-contact connector B. No. 209 458, AMP No. 42 859/1 (Fig. 3)

Connection to amplifier

In combination units, i.e. hifi stereograms, the connection of the turntable to the amplifier already is done.

The unit can be fitted with DIN 41 524 miniature connectors (Fig. 4) or with phono (RCA) plugs (Fig. 5).

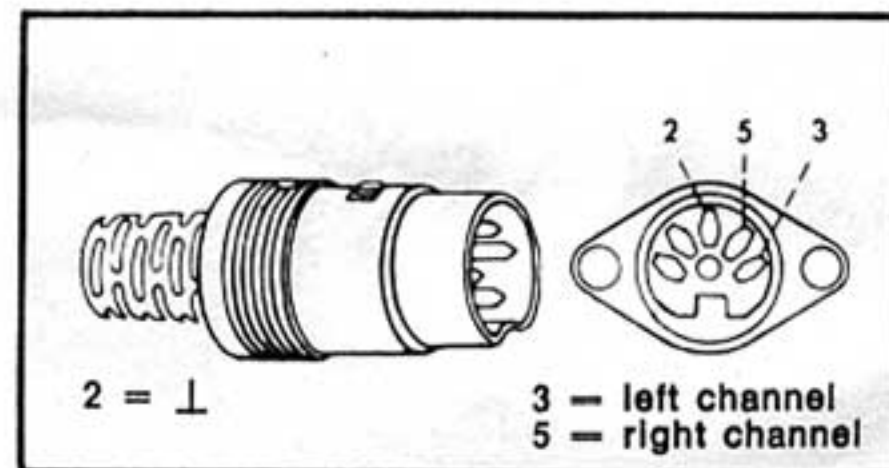

Fig. 4

If your amplifier is fitted with a different type of connector, use suitable adapters, available from radio dealers.

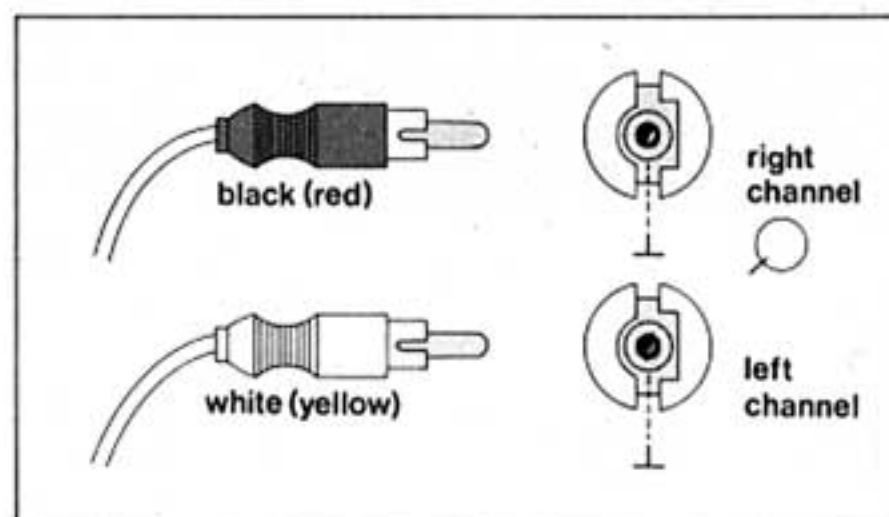

Fig. 5

If the unit is to be connected to a universal ("ac-dc") radio, amplifier with similar circuit, a suitable ground connection must be made to prevent possible shock hazard. A contact is available for this purpose on the power connector (Figs. 2 and 3).

Controls

- ① Pitch control knob
- ② Speed selector
- ③ Single-play spindle
- ④ Tonearm grip and lock
- ⑤ Cartridge holder
- ⑥ Tonearm rest
- ⑦ Tonearm cue control height adjustment
- ⑧ Stylus force adjustment
- ⑨ Adjustment screw for tonearm balance
- ⑩ Cue control
- ⑪ Tonearm lock
- ⑫ Tonearm set-down adjustment
- ⑬ Record size selector
- ⑭ Operating switch for automatic start and stop
- ⑮ Chassis hold down screw (for transport)
- ⑯ Multiple-play spindle AW 3
- ⑰ Adapter for large-hole records
- ⑱ Multiple-play spindle AS 12 for large-hole records (special accessory)

Operation as single player

Insert the short, single-play spindle (and, for 45 rpm records, the center-hole adapter), then place the desired record on the turntable.

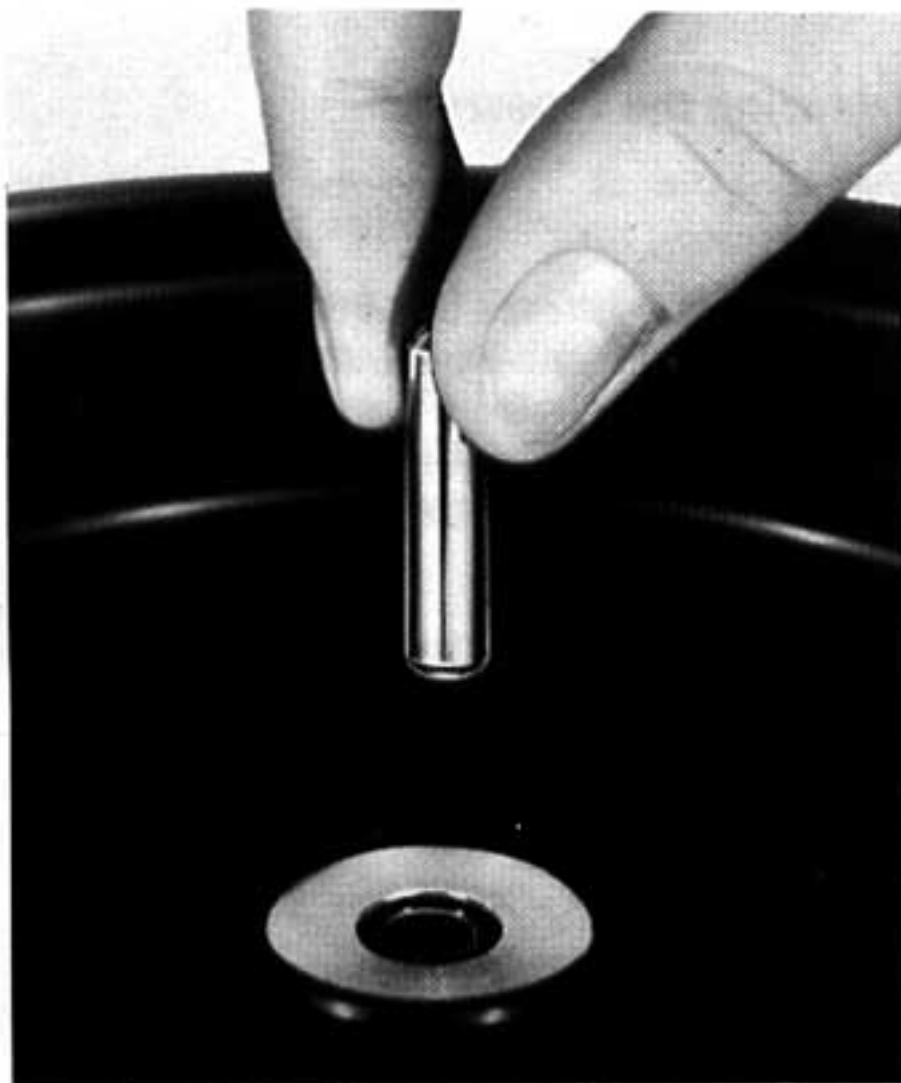

Fig. 6

Select the appropriate turntable speed ②, set the record size selector ⑬ to 7", 10" or 12" resp. (12, 25 or 30 cm), depending on the size of the record you want to play, and unlock the tonearm (Fig. 7).

Now the unit is ready to play.

1. Automatic tonearm set-down

Push the operating switch to "start". The motor will start, the tonearm will rise, move to the record, then descend onto the record.

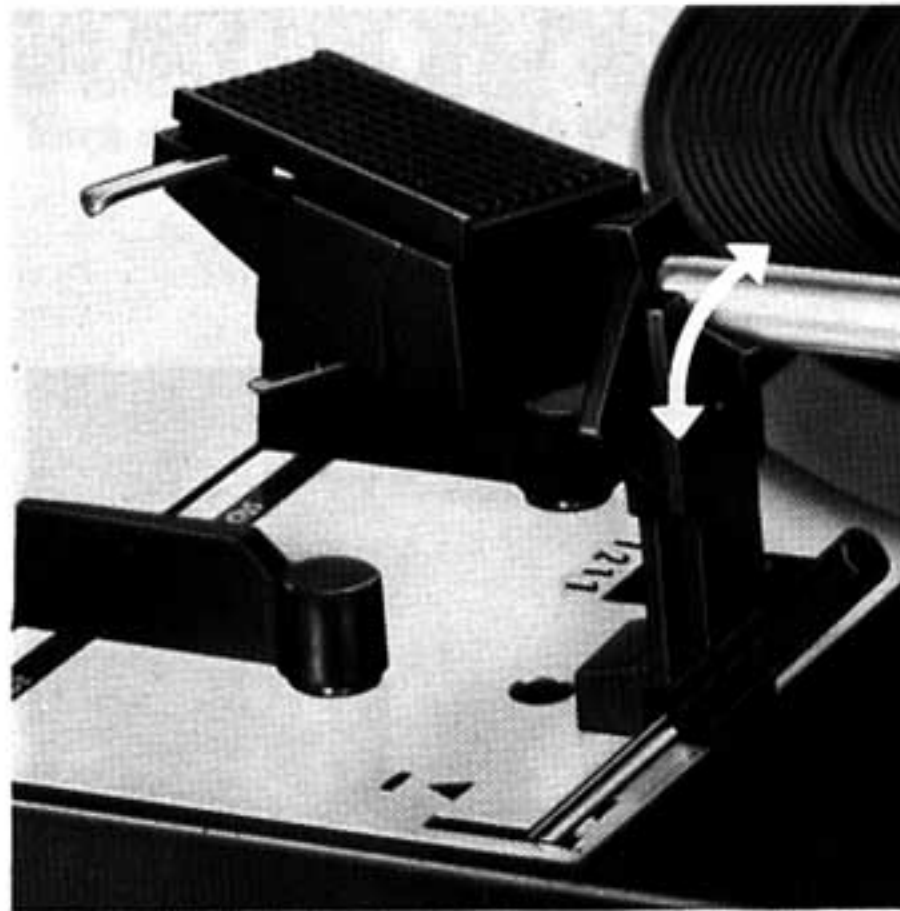

Fig. 7

2. Automatic start with cue control



First move the cue control lever to , then push the operating switch to "start". The tonearm will descend very slowly and land on the record without jarring in the slightest, controlled by the silicone damping of the cue control system.



Fig. 8

3. Manual operation

- a) Move the cue control lever to position .
- b) Move the tonearm by hand over the desired spot on the record.
- c) Gently move the lever back to . (The tonearm will descend.)

4. To repeat a record

Push the operating switch to "start".

5. To interrupt play

Move the cue-control to .

When the tonearm is returned to playing position, the last few phrases of music already played will be repeated.

6. To stop

Move the operating switch to "stop". The tonearm will return to its rest and the motor will shut off.

Note: At the end of a record, or at the end of the last record of a stack, return of the tonearm and switch-off are automatic. It is advisable to lock the tonearm in place (Fig. 7) after turning off the system.

Operation as record changer

Insert the changer spindle ⑯ or the changer column* ⑱ so that the pin fits into the slot in the shaft.

Lock the spindle in place by pressing down on it as you turn it to the right, until it stops. Stack up to six records of the same size and speed on the multiple-play spindle or the special one for large-hole 45 rpm records. When you move the operating switch to "start", the first record will drop and the tonearm will lift, move to the record, then descend. If you wish to reject a record that is playing and move on to the next, move the operating switch once again to "start".

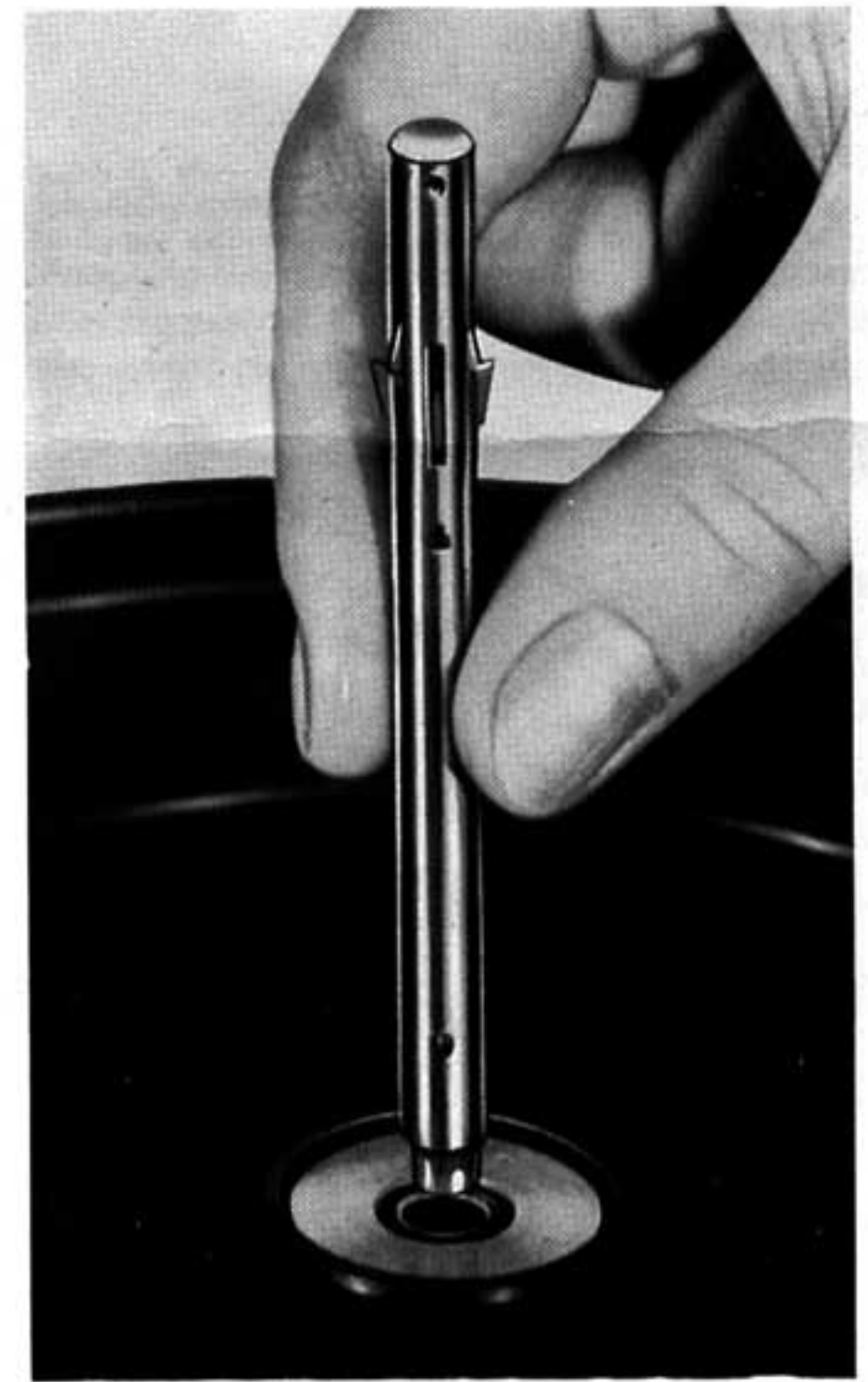

Fig. 9

Note: Records already played can be lifted back onto the spindle platform for replay or removed entirely. The spindle need not be removed.

* The optional accessory changer column AS 12 can be obtained from your dealer.

Continuous automatic playing

Once the record has been laid down on the platter, insert the centering piece through the



Fig. 10

multiple-play spindle. It is advisable to place a 45 rpm record on top of the centering piece for added weight. The record will then play continuously without interruption.

Technical notes

Cartridge (pick-up)

The following instructions apply only if your unit was purchased without a cartridge installed, or if you wish to replace the cartridge supplied with one of your own choosing.



Fig. 11

Fitment of the cartridge should be done by an authorized Dual service dealer. When

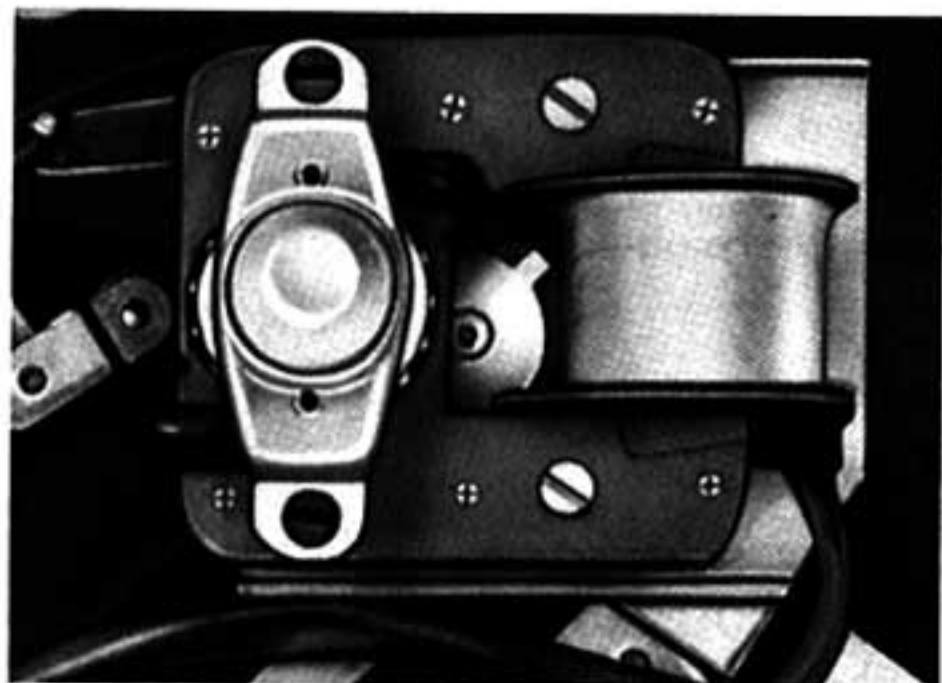

Fig. 12

mounting the cartridge, use the built-in cartridge holder or another cartridge holder (Dual TK 14, Article No. 215 420).

Any piezoelectric pick-up with a weight of 1 – 10 gms. and 1/2" mounting centers can be mounted in the unit.

A magnetic cartridge with a minimum tracking force of 2 p can also be used in a unit with a four-pole motor (Fig. 13).

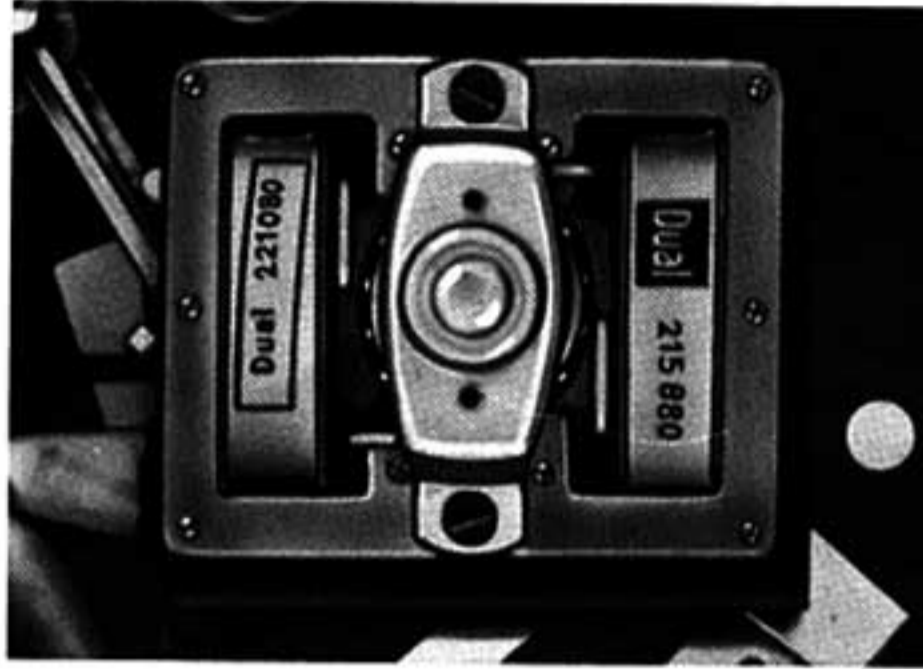

Fig. 13

1. To install a cartridge, remove the cartridge holder from the tonearm by pressing the grip toward the rear. Hold the cartridge holder or it will fall out once unlocked.
2. Fasten the cartridge with the help of the mounting accessory supplied with the cartridge holder Dual TK 14 and the cartridge. Be sure it is located correctly (Fig. 14).

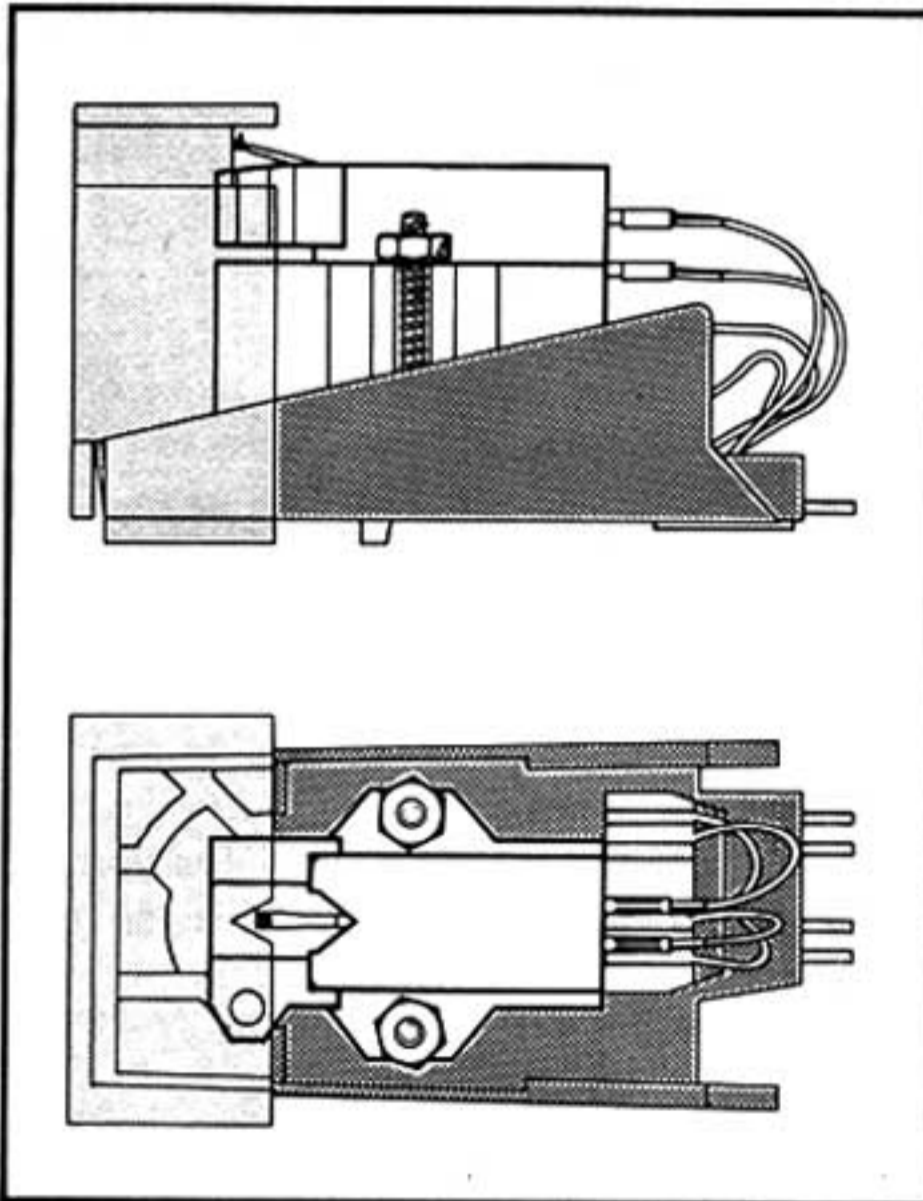

Fig. 14

3. The connections on the cartridge holder are marked and the wire leads are color-coded (Fig. 15). Connect the leads with the appropriate terminal pins on the cartridge.

4. Re-insert the cartridge holder in the tonearm head from underneath, and secure it by moving the tonearm grip forward.

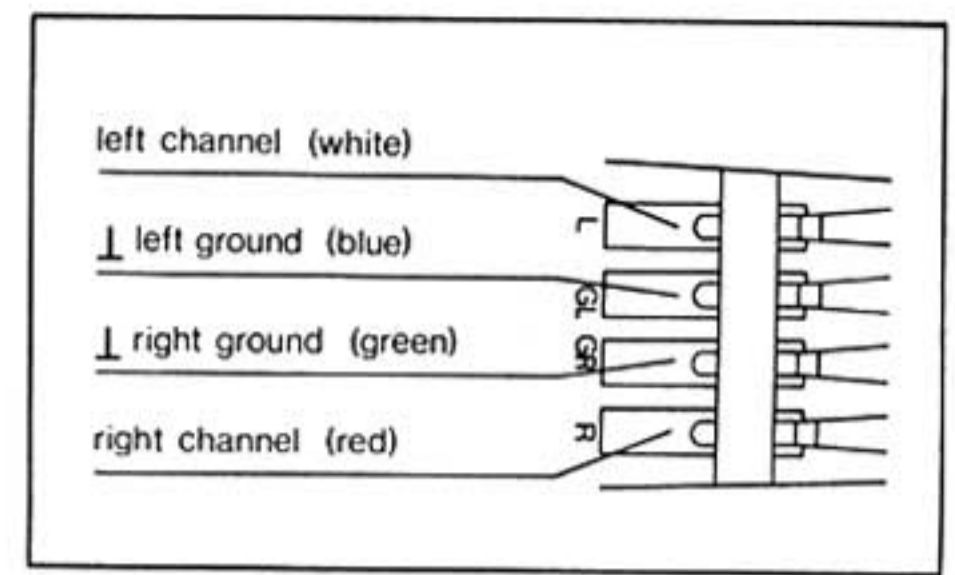

Fig. 15

Stylus

The stylus will of course wear out after a certain amount of use. We recommend that the diamond stylus should be checked after playing about 300 hours and a sapphire stylus should be checked after playing about 30 hours. Your authorized dealer will be glad to check your stylus free of charge.

A worn out or damaged stylus chisels the modulations in the grooves and damages the record. Replace the worn out stylus with one that meets exactly the cartridge's specifications. Imitations will result in a loss in sound quality and will increase the damage on your records.

Please notice that the stylus carrier with a sapphire or diamond stylus, due to size, is very sensitive to shocks, vibrations or sudden impacts. Owing to this fact, please do not replace the stylus yourself. In order to have your stylus changed take the complete cartridge (with stylus) and have it done by your nearest authorized dealer.

Balancing the tonearm

The tonearm is balanced by rotating the knurled screw.

1. Set the stylus force to zero.
2. Unlock the tonearm, and lift it off the rest. Move the tonearm just to the inside of the resting post and turn the tonearm counter-balance until the tonearm floats in horizontal position.

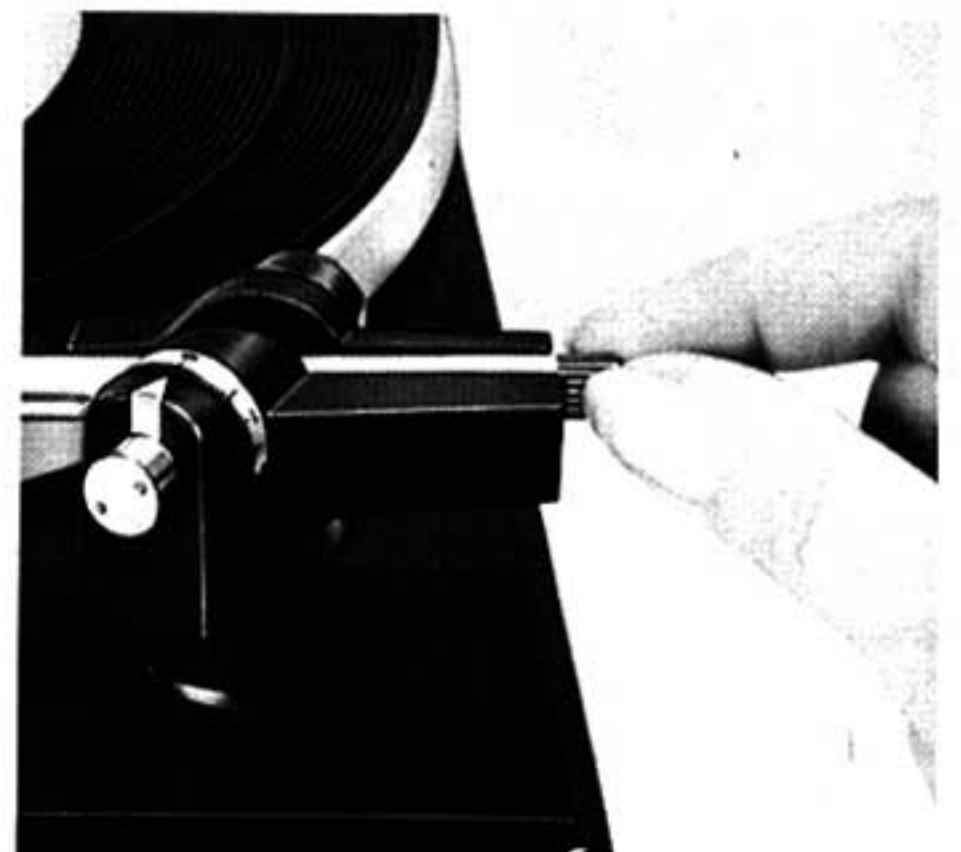

Fig. 16

Turning the screw weight counterclockwise raises the tonearm head, turning it clockwise lowers the tonearm.

The tonearm is precisely balanced when edge "A" of the tonearm head and edge "B" of the tonearm rest are at equal height (Fig. 17) or when the tonearm returns by itself to a horizontal position after the chassis is tapped.

Precise balance is especially important with cartridges that require a low stylus force. The balancing operation need be done only once, unless you install a different cartridge.

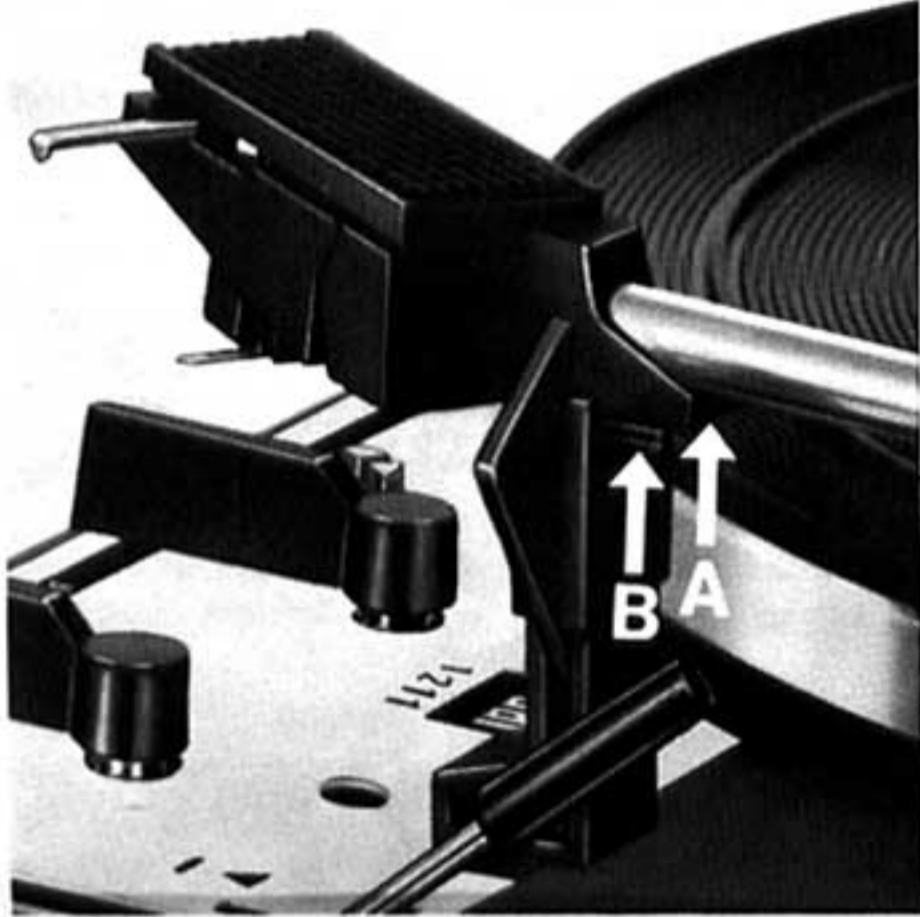

Fig. 17

During the balancing of the tonearm the operating switch must be in its neutral position, so that the tonearm is disengaged from the automatic mechanism. To be sure, lock the tonearm on the rest post, then rotate the turntable platter by hand, clockwise, until the operating lever returns to its neutral position.

Setting stylus force

Once the tonearm is balanced, set the stylus force by turning the stylus force dial. The force is continuously adjustable from zero to 5.5 grams. The unit will function properly with as little as 2.5 gram stylus force.



Fig. 18

Every cartridge has an optimum tracking force, which provides the best reproduction. For the best figure for your cartridge, consult the information provided with it.

For factory-installed cartridges, you will find all necessary details in a leaflet that accompanies these instructions.

Too low a stylus force produces distortion in loud recorded passages. Too high a stylus force can damage the stylus and record.

Cue control

Your automatic turntable is equipped with a precise, jolt-free, silicone-damped tonearm lifting device. With this cue control, the tonearm can be placed over any spot on a record, then lowered more gently than possible by hand. The rate of descent is independent of temperature.

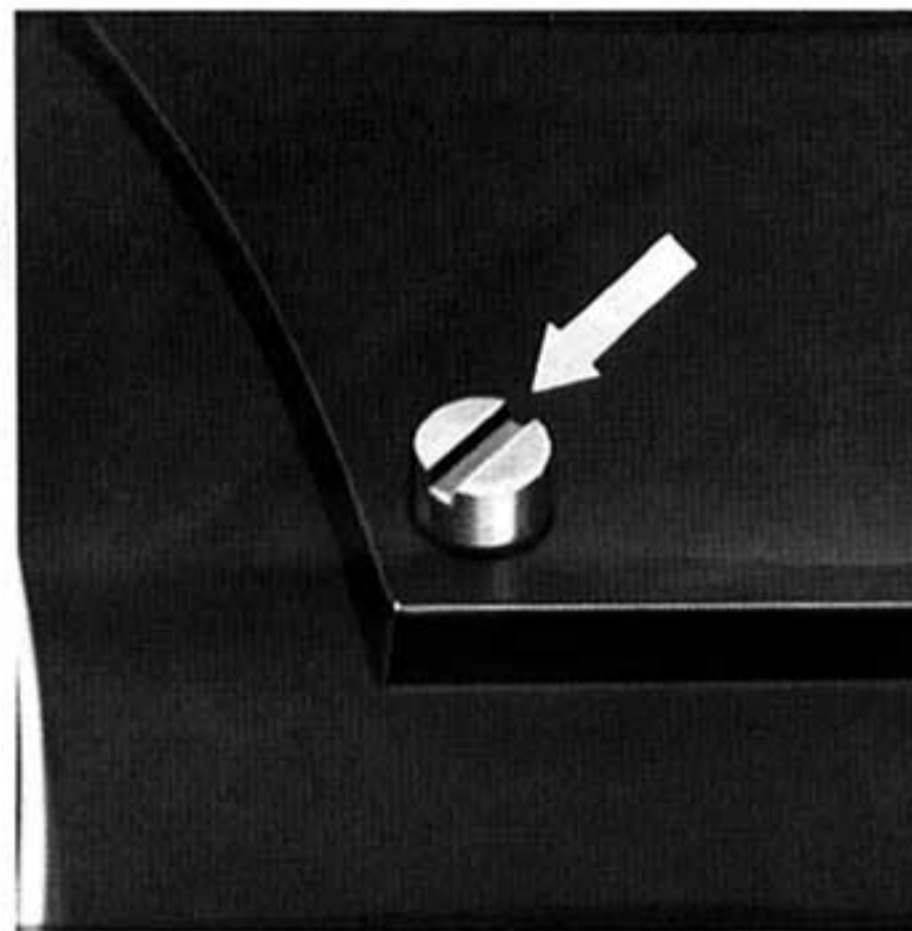





Fig. 19

Its operating lever has two positions:

playing position 

lift position  , in which the tonearm is lifted off the record surface. A light tap backwards on the lever starts the tonearm descending. The height of the stylus above the record in the  position can be adjusted from zero to about 6 mm (1/4") with screw .

Pitch control

Each of the three standard speeds (33 1/3, 45 and 78 rpm) can be varied about 6 % (approximately one musical semitone). The speed can be checked with the stroboscopic disc, illuminated by a light powered from alternating household current. The ring of lines corresponding to the chosen speed will appear to stand still when the turntable is rotating at the correct speed.

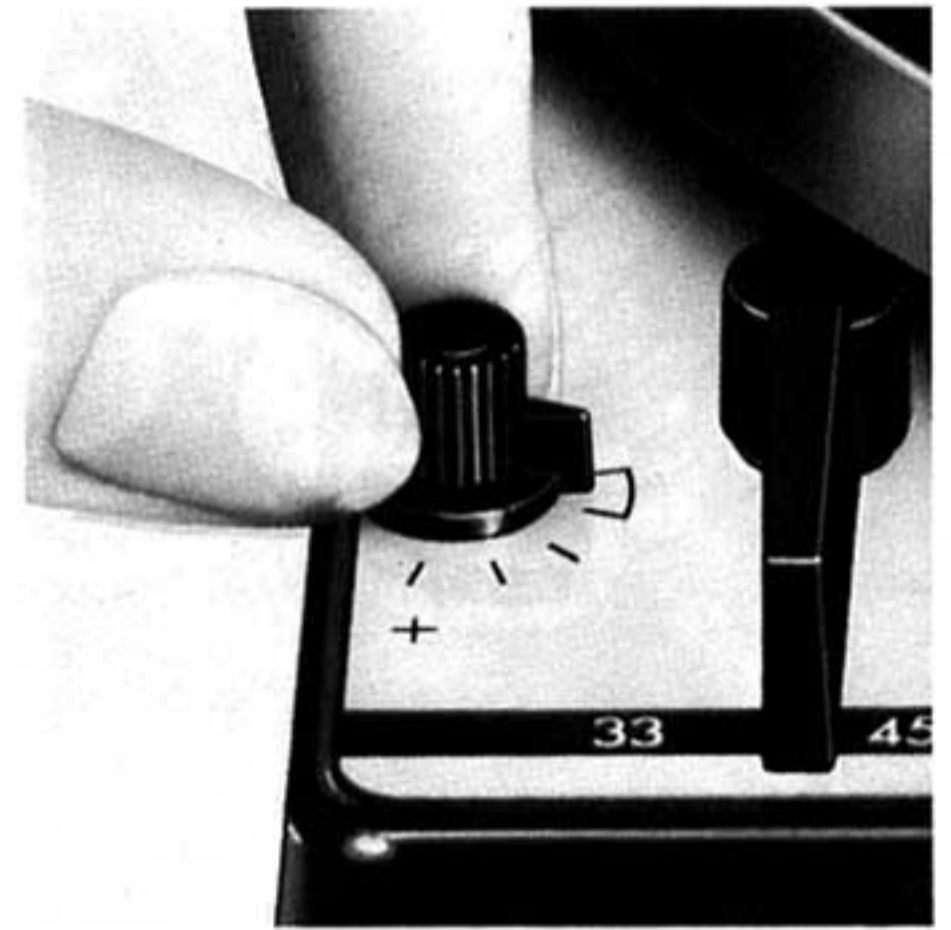



Fig. 20

Pitch is varied by using the pitch control knob .

Line frequency 50 or 60 Hz

Adapting the unit for use at a different power-line frequency is accomplished by changing the motor pulley (A), which is secured to the motor shaft by a screw and can be reached by removing the turntable.

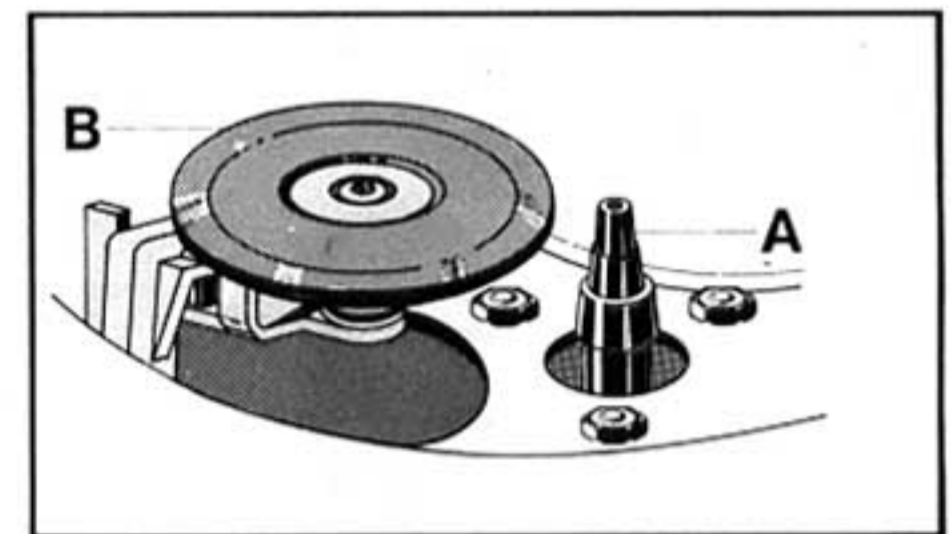

Fig. 21

Caution: Handle the motor pulley carefully. A bent pulley causes rumble.

Part Numbers for motor pulleys:

| | |
|---------------|--------------------|
| 2-pole motor, | 50 Hz: No. 212 135 |
| | 60 Hz: No. 212 136 |
| 4-pole motor, | 50 Hz: No. 220 970 |
| | 60 Hz: No. 220 971 |

Removing the turntable

The turntable is secured by a C-ring seated in a notch on the turntable shaft. Use a screwdriver to remove the C-ring, then lift off the turntable.

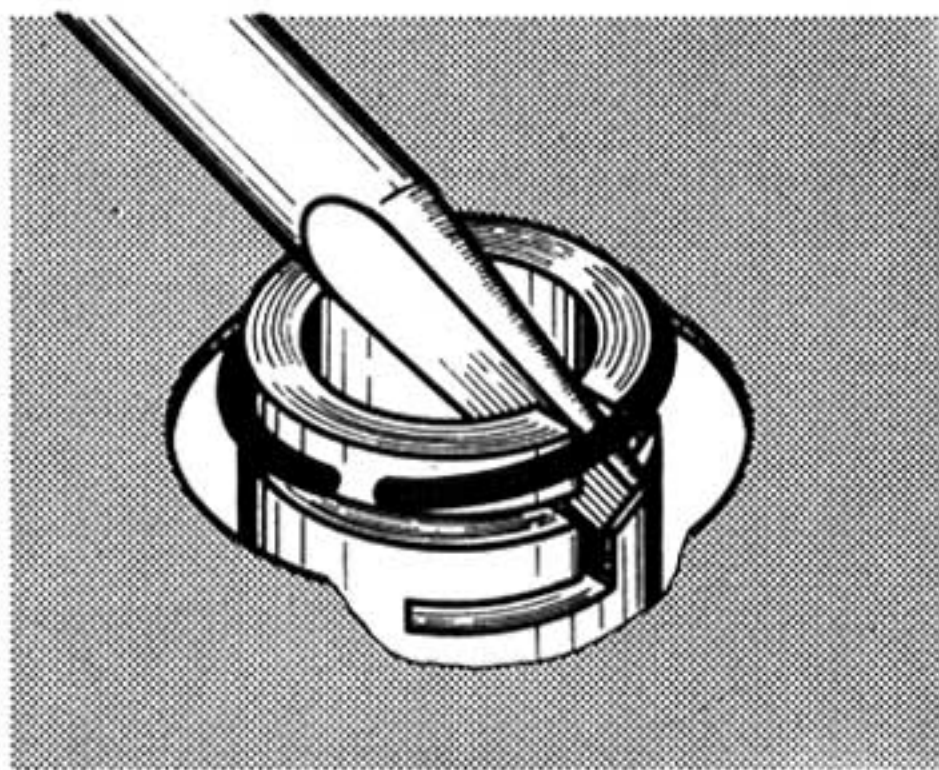

Fig. 22

Important: When handling the turntable avoid touching the inner surfaces with your fingers as skin oils can cause slippage (and resulting pitch deviation) between the idler wheel and the driving rim of the turntable.

Adjusting tonearm set-down position

With automatic start, the stylus descends automatically into the outer groove of the record. It is possible, due to peculiarities in the mounting of a cartridge, that the stylus may land too far in or too far out on the record.

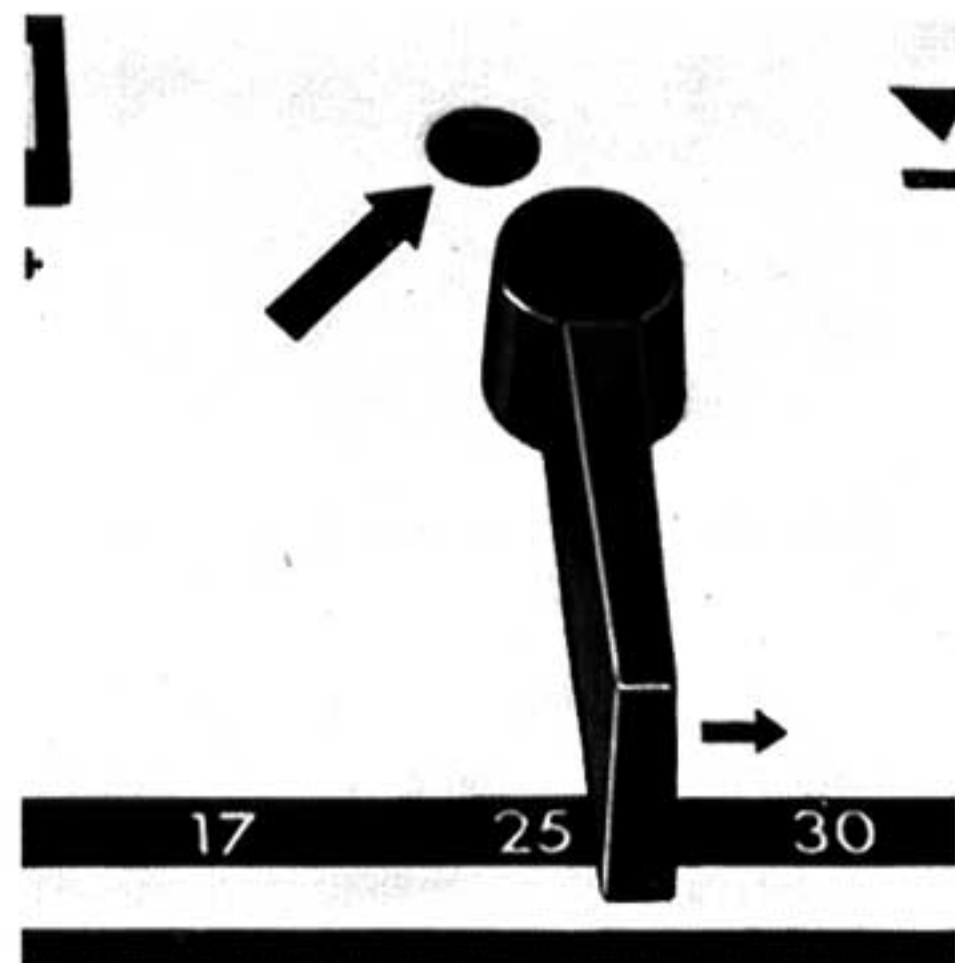

Fig. 23

In that case, set the record size selector for a 12" record (30 cm). Through the hole next to the tonearm rest, you will see an adjustment screw⁽¹²⁾. If the stylus lands too far into the record, turn the screw slightly to the left; if it lands too close to the edge, turn it slightly to the right.

Service

All parts that require lubrication are liberally coated with oil. Under normal conditions, your Dual will function perfectly for years. Do not oil any parts; special oils must be used. Should your Dual ever require service, either take it to your dealer or ask him for the address of the nearest authorized Dual service agency. Be sure that original Dual replacement parts only are used. Always ship your Dual in its original packing.

Technical data

Power supply:

50 or 60 Hz, AC
changeable by changing motor pulley

Power supply voltage:

110/117 and 220/240 V, switchable

Drive:

2-pole Dual single-phase induction motor or
4-pole asynchronous motor

Power consumption:

≤ 10 watts

Current drain:

60 mA approx. at 220 V, 50 Hz
115 mA approx. at 117 V, 60 Hz

Turntable

dia. 10 5/8", weighing 3.2 lbs.

Turntable speeds:

33 1/3, 45 and 78 r.p.m.

Pitch control variation:

adjustment range of approx. 1 semitone (6%)
at all three turntable speeds

Speed accuracy deviation:

< ± 0.17 % in accordance to DIN 45 507

Rumble:

≥ 35 dB below signal level in accordance to
DIN 45 500

Weighted rumble:

≥ 55 dB below signal level in accordance to
DIN 45 500

Tonearm:

torsionally rigid, tubular metal arm with ver-
tical needle bearings, horizontal ball bearings
Minimum tracking force: 3 p

Cartridge holder:

removable, suitable for acceptance of
cartridges having 1/2" mounting and posses-
sing a weight of 1 - 8 grams.

Weight:

9.7 lbs. without packing

Dimensions:

12 7/8 x 10 3/4"